

# OXUS ehf

Umboðs- og heildverslun

## Vörulisti 2024

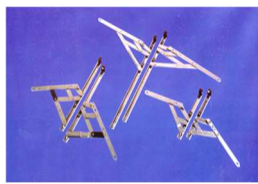

Akralind 6  
201 Kópavogi  
Sími 5 444 888  
Fax 5 444 889  
Netfang: [oxus@oxus.is](mailto:oxus@oxus.is)  
[www.oxus.is](http://www.oxus.is)

Mest seldu gluggalamirnar á Íslandi í 20 ár



## Ryðfríar brautalamir fyrir opnanleg fög

Avocet brautalamirnar eru allar úr SS304 ryðfríu stáli og hafa staðist kröfur samkvæmt : MOAT No. 1: 1974 UEAtc "Directive for the Assessments for Windows". Rannsóknarstofnun Byggingariðnaðarins hefur farið yfir þær prófanir og hefur samþykkt notkun þeirra við íslenskar aðstæður (prófun Nr.H02/79) í samræmi við leiðbeiningar framleiðanda. Avocet brautalamirnar eru til fyrir topphengd og hliðarhengd fög. Þær eru fyrir mjög algengt úrtak, 16 x 5.5 mm úrtak í karmi og 16 x 2.5 mm í falsi. Bil milli karms og fals þarf að vera 6 mm. Topphengdu brautalamirnar eru með barnaöryggi í 12", 16", 20" og 24" stærðum.

Hliðarhengdu brautalamirnar henta mjög vel fyrir neyðarútganga þar sem þær koma í svokallaðri "EGRESS" útgáfu og opnast beint í 90°. Einnig er hægt að nota hliðarhengdar lamir í topphengd fög ef óskað er eftir að fag lækki ekki niður við opnun.

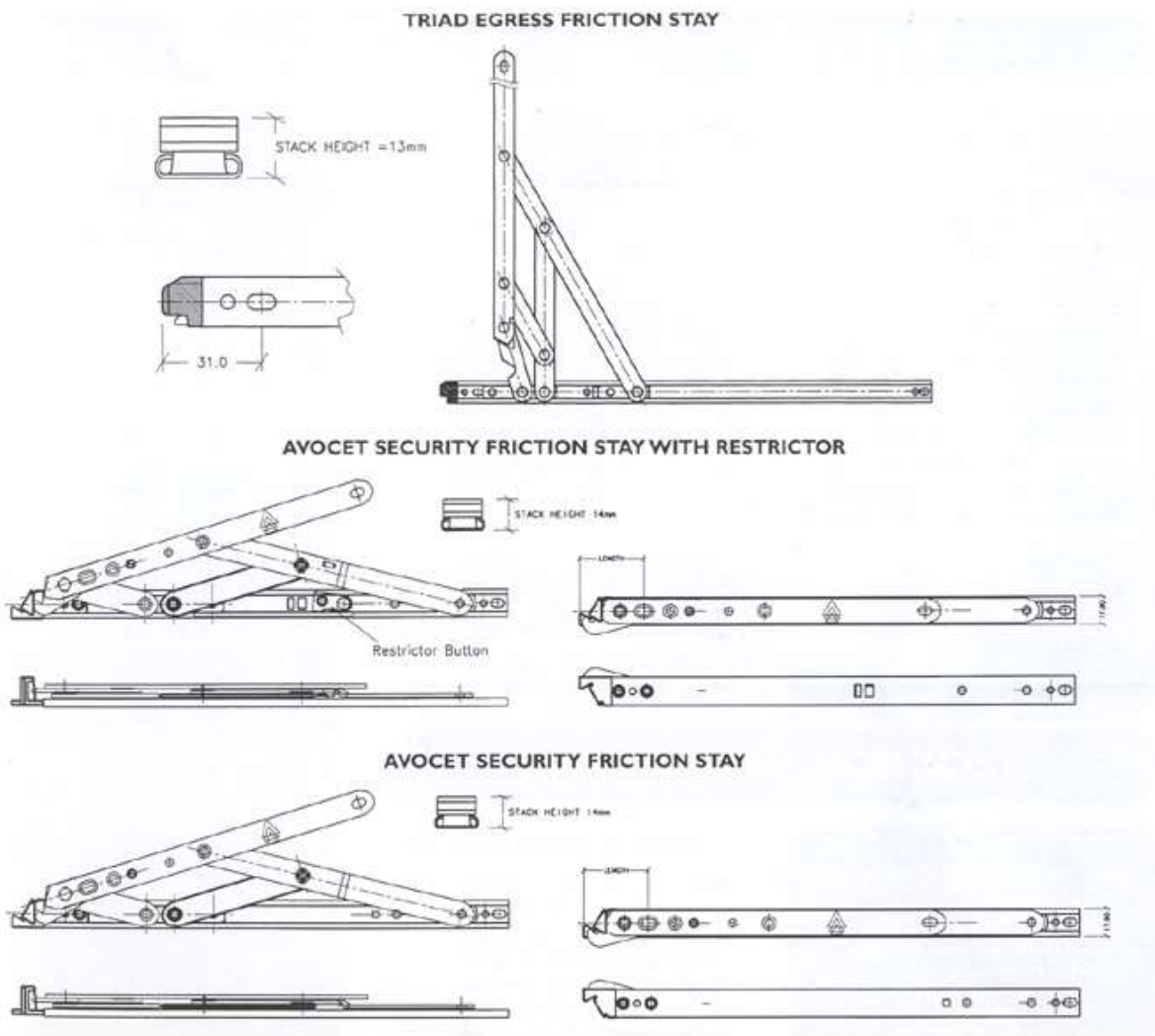

| Vörunnr. | Vöruheiti                                  | Lengd      | Breidd botns og arms | Hámarks kg. | Hámarks hæð faga | Pakkning        |
|----------|--|------------|----------------------|-------------|------------------|-----------------|
| 41608    | Avocet brautalöm topphengd RF              | 8" /20 cm  | 15,5 mm              | 12 kg       | 35 cm            | 5 x 10 pör í ks |
| 41610    | Avocet brautalöm topphengd RF              | 10" /25 cm | 15,5 mm              | 14 kg       | 40 cm            | 6 x 10 pör í ks |
| 416121   | Avocet brautalöm topphengd RF <b>BÖ</b>    | 12" /30 cm | 15,5 mm              | 16 kg       | 55 cm            | 4 x 10 pör í ks |
| 416162   | Avocet brautalöm hliðhengd RF (breidd)     | 16" /40 cm | 15,5 mm              | 24 kg       | 120 x 65 cm      | 4 x 10 pör í ks |
| 416161   | Avocet brautalöm topphengd RF <b>BÖ</b>    | 16" /40 cm | 15,5 mm              | 20 kg       | 80 cm            | 3 x 10 pör í ks |
| 416201   | Avocet brautalöm topphengd RF <b>BÖ</b>    | 20" /50 cm | 15,5 mm              | 24 kg       | 90 cm            | 3 x 10 pör í ks |
| 416241   | Avocet brautalöm topphengd RF HD <b>BÖ</b> | 24" /60 cm | 15,5 mm              | 35 kg       | 120 cm           | 2 x 10 pör í ks |

**BÖ** = Barna öryggi  
 RF = Ryðfrítt  
 HD = Heavy Duty (sérstyrktar)

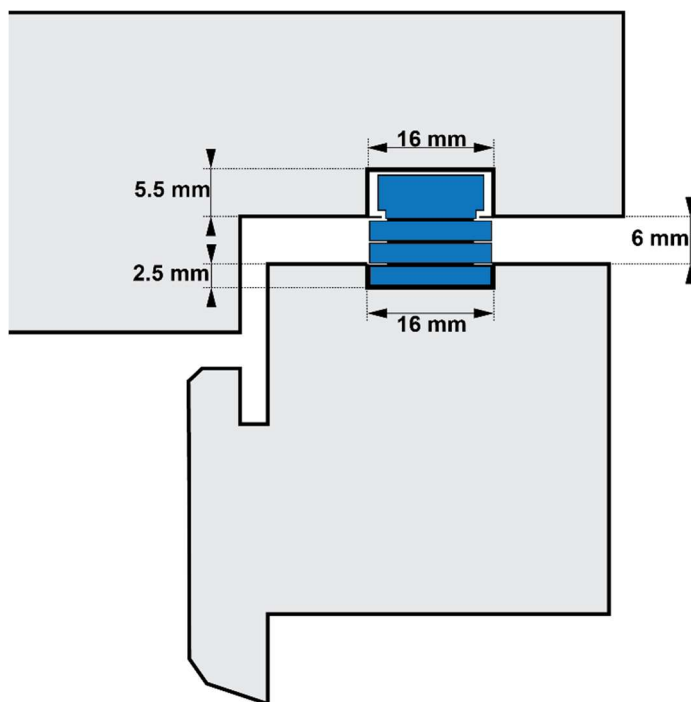



## Brautalamir

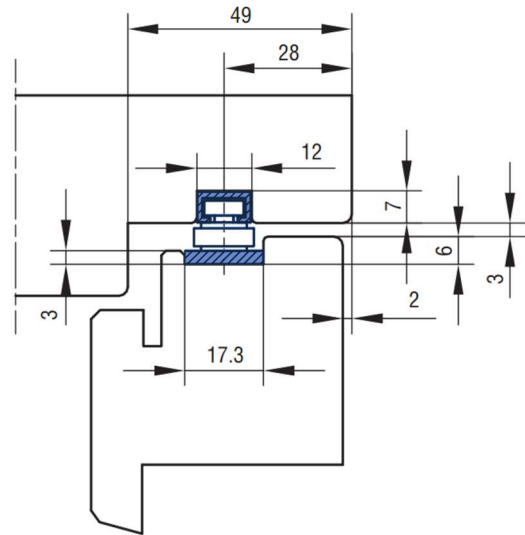
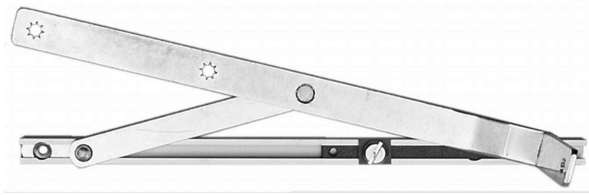

| Vörunr. | Vöruheiti            | Lengd  | Breidd botns og arms | Hámarks kg. | Hámarks hæð fags | Pakkning |
|---------|----------------------|--------|----------------------|-------------|------------------|----------|
| 419175  | IPA Brautalamir 12x7 | 160 mm | 12 og 17 mm          | 20 kg       | 30 cm            | 5        |
| 419170  | IPA Brautalamir 12x7 | 263 mm | 12 og 17 mm          | 40 kg       | 84 cm            | 25       |
| 419173  | IPA Brautalamir 12x7 | 453 mm | 12 og 17 mm          | 50 kg       | 134 cm           | 25       |
| 419174  | IPA Brautalamir 12x7 | 711 mm | 12 og 17 mm          | 70 kg       | 154 cm           | 5        |

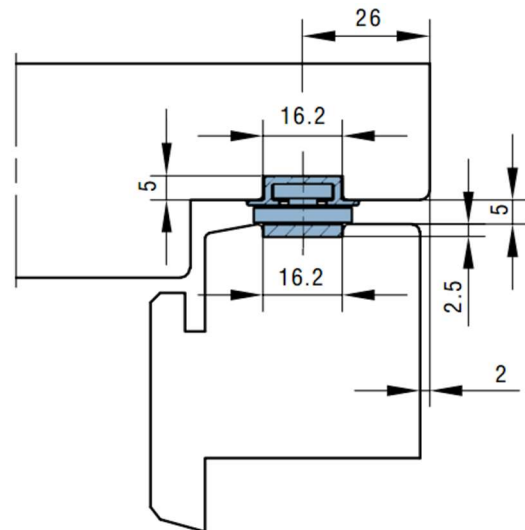

| Vörunr. | Vöruheiti            | Lengd  | Breidd botns og arms | Hámarks kg. | Hámarks hæð fags | Pakkning |
|---------|----------------------|--------|----------------------|-------------|------------------|----------|
| 418575  | IPA Brautalamir 16x5 | 160 mm | 16 mm                | 20 kg       | 30 cm            | 5        |
| 418570  | IPA Brautalamir 16x5 | 263 mm | 16 mm                | 40kg        | 84 cm            | 25       |
| 418573  | IPA Brautalamir 16x5 | 453 mm | 16 mm                | 50 kg       | 134 cm           | 25       |
| 418574  | IPA Brautalamir 16x5 | 711 mm | 16 mm                | 70 kg       | 154 cm           | 5        |



## Býskar skrár fyrir innihurðir

**BKS skrárnar** koma með ryðfrírri framhlið og slúttjárnnum. 3 gerðir. Fyrir Euro-síldra, lykla og baðsnerla. Skrá fyrir það er fyrir 8 mm pinna.



660415H/V



660215H/V



660216H/V

| Vörunr.  | Vöruheiti                        | Lengd framhliðar | Breidd framhliðar | Litur | Dýpt gats / heildardýpt | Leng milli gata |
|----------|----------------------------------|------------------|-------------------|-------|-------------------------|-----------------|
| 660215H  | BKS skrá fyrir lykla hægri       | 235 mm           | 24 mm             | RF    | 55/80 mm                | 72 mm           |
| 660215V  | BKS skrá fyrir lykla vinstri     | 235 mm           | 24 mm             | RF    | 55/80 mm                | 72 mm           |
| 660216H  | BKS skrá fyrir baðsn. hægri      | 235 mm           | 24 mm             | RF    | 55/80 mm                | 72 mm           |
| 660216V  | BKS skrá fyrir baðsn. vinstri    | 235 mm           | 24 mm             | RF    | 55/80 mm                | 72 mm           |
| 660415H  | BKS skrá fyrir Euro síl. hægri   | 235 mm           | 24 mm             | RF    | 55/80 mm                | 72 mm           |
| 660415V  | BKS skrá fyrir Euro síl. vinstri | 235 mm           | 24 mm             | RF    | 55/80 mm                | 72 mm           |
| 663535SL | Euro sílinder 35x35 mm SL        |                  |                   | Króm  |                         |                 |
| 664040SL | Euro sílinder 40x40 mm SL        |                  |                   | Satin |                         |                 |
| 663555SL | Euro sílinder 35x55 mm SL        |                  |                   | Satin |                         |                 |
| 664545SL | Euro sílinder 45x45 mm SL        |                  |                   | Satin |                         |                 |
| 665535SL | Euro sílinder 55x35 mm SL        |                  |                   | Satin |                         |                 |

Eigum til töluvert úrval af RF húnum og rósettum fyrir BKS skrárnar.



### Euro sílindrar





## Sjálfvirkar og venjulegar þriggja punkta útihurðalæsingar

### Automatic

Einnig fánleg með rafmagnsmótor. Fyrir fjarstýrða opnun dyrasíma eða fjarstýringu.

|                     |                |
|---------------------|----------------|
| Lásbolti            | 35 mm x 20 mm  |
| Efni                | Stál           |
| Litur/húð           | Krómað         |
| Lástegund           | Euro sílinder  |
| Láshús              | 70 mm x 195 mm |
| Láshús uppi / niðri |                |
| Lásmiðja (handf.)   | 55 mm          |
| Lásmiðja í læsingu  | 92 mm          |
| Lengd               | 2285 mm        |

### Basic

|                    |                    |
|--------------------|--------------------|
| Uppi / Niðr        | 16 mm shootbolt    |
| Lásbolti           | 35 mm x 20 mm      |
| Efni               | Stál               |
| Litur/húð          | Krómað             |
| Lástegund          | Euro sílinder      |
| Láshús             | 70 mm x 195 mm     |
| Lásmiðja (handf.)  | 55 mm              |
| Lásmiðja í læsingu | 92 mm              |
| Lengd              | 1375mm + 742/973mm |
| mm                 |                    |

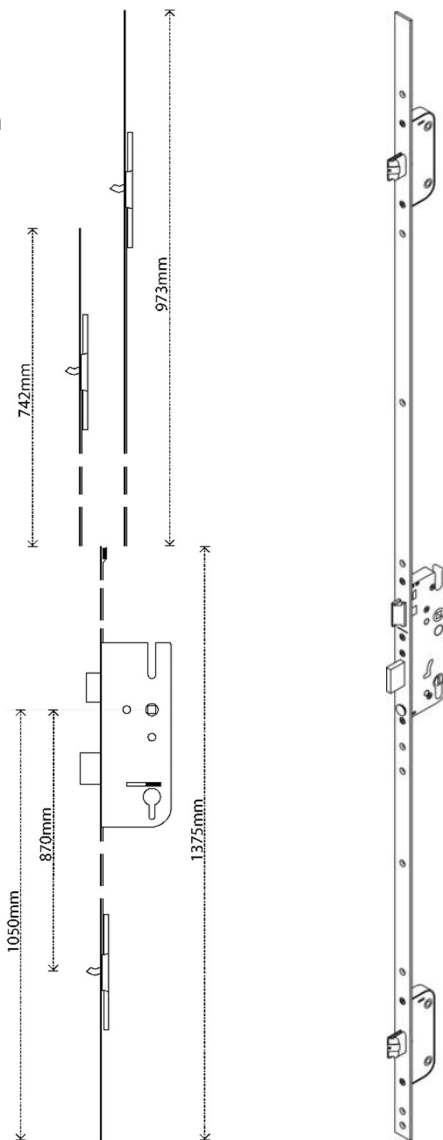
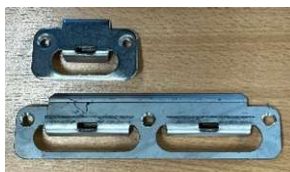

Basic

Automatic

Slúttjárn stillanleg 622851-52

Slúttjárn RF 62282-84

| Vörunr.   | Vöruheiti                   | Lengd     | Dýpt gats   | Litur | Láshús mm | Pakkning |
|-----------|-----------------------------|-----------|-------------|-------|-----------|----------|
| 62290-1-2 | G-U Útihurðalæsing Basic    | 1375 mm   | 35-50-55 mm | Króm  | 70x195 mm | 5 stk    |
| 62294     | G-U Framlenging f/ Basic    | 742 mm    |             | Króm  |           | 5 stk    |
| 62296     | G-U Framlenging f/ Basic    | 973 mm    |             | Króm  |           | 5 stk    |
| 62216     | G-U Útihurðalæsing Autom.   | 2285 mm   | 55 mm       | Króm  | 70x195 mm | 5 stk    |
| 62226     | G-U Framlenging f/ Autom.   | 500 mm    |             | Króm  |           | 5 stk    |
| 62282-4   | Slúttjárn RF. Miðja / Endar | 65/167 mm |             | RF    |           |          |
| 622851-2  | Slúttjárn Stillanl. M / E   | 125/195mm |             | Króm  |           |          |



## GU Raflæsingabúnaður fyrir útihurðir / Intensa Rafhúnar

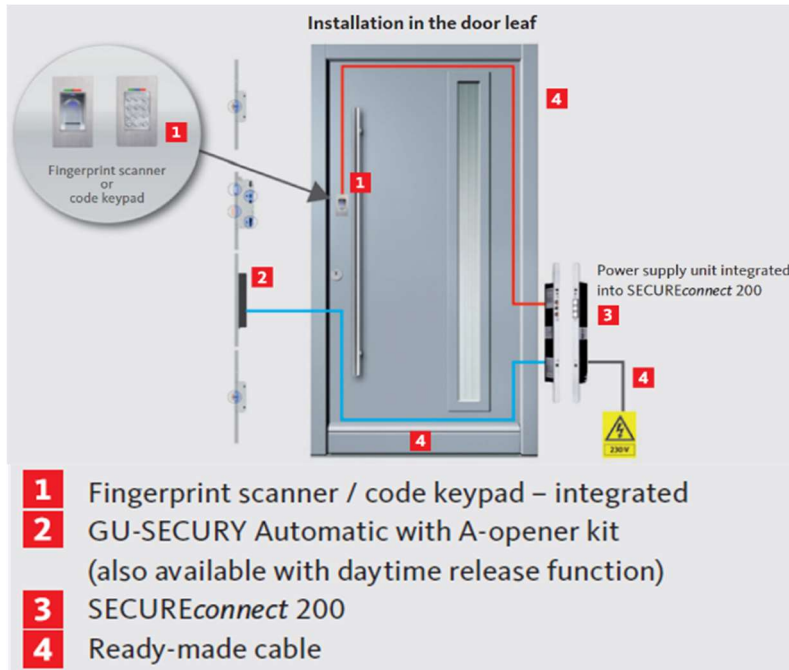

GU Raflæsingar í hurð



A-Opener mótör sett



SECUREconnect 200

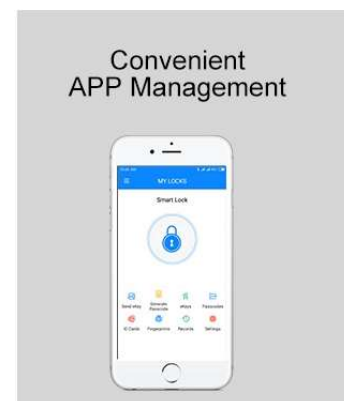
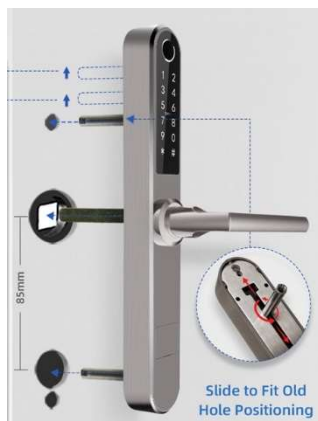

| Vörunr. | Vöruheiti   | Pakkning |
|---------|---|----------|
| 623002  | G-U A-Opener Mótör sett fyrir raf-útihurðalæsingu Automatic       | 1        |
| 623004  | G-U SECUREconnect 200 fyrir Raflæsingar                           | 1        |
| 623012  | G-U Raflæsinga sett með Keypad, Mótör, Connector                  | 1        |
| 623150  | G-U Hlífar fyrir SECUREconnect í hurð og karm                     | 1        |
| 622866  | Intensa Rafhúnn. Talnalás, ID kort, Bluetooth og Lykill / Silfur. | 1        |
| 622868  | Intensa Rafhúnn. Talnalás, ID kort, Bluetooth og Lykill / Svartur | 1        |



## Gluggalæsingar með stýripinna og mótstykki, úr ryðfríu stáli, með næturopnun

|                |                         |
|----------------|-------------------------|
| Stólpi / Plata | 16/17 mm                |
| Efni           | Járn                    |
| Yfirborð       | Krómað                  |
| Sveppir        | Ryðfrír                 |
| Fjöldi sveppa  | 2 stk. (300-1200mm)     |
| Stýritappi     | 1 stk. í miðju. Ø 11 mm |
| Húnagat        | 8 mm                    |
| Húnagatsdýpt   | 28 mm (Backset)         |
| Láshússdýpt    | Húngatsdýpt + 9 mm      |
| Lengd          | (L) í töflu             |
| Lengd m/sveppa | (C) í töflu             |

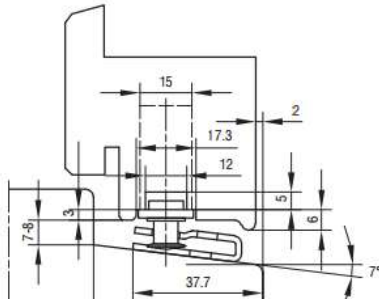

RF mótstk. fyrir gluggalæs  
Vörunr: 61900

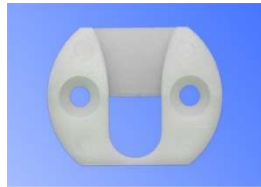

Klossi fyrir stýripinna  
Vörunr: 61901

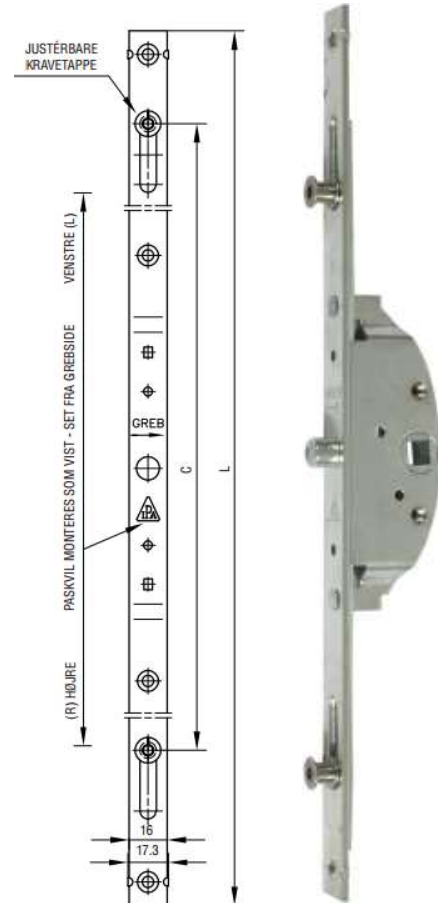

| Vörunr. | Vöruheiti                      | Lengd (L)   | Milli kólva (C) | Dýpt / Húnagat | Litur | Pakkning |
|---------|--------------------------------|-------------|-----------------|----------------|-------|----------|
| 60300   | IPA Gluggalæsing m/stýringu 16 | 300 mm (2)  | 190 mm          | 28 / 8 mm      | Krómm | 10       |
| 60400   | IPA Gluggalæsing m/stýringu 16 | 400 mm (2)  | 295 mm          | 28 / 8 mm      | Krómm | 10       |
| 60500   | IPA Gluggalæsing m/stýringu 16 | 500 mm (2)  | 395 mm          | 28 / 8 mm      | Krómm | 10       |
| 60600   | IPA Gluggalæsing m/stýringu 16 | 600 mm (2)  | 495 mm          | 28 / 8 mm      | Krómm | 10       |
| 60700   | IPA Gluggalæsing m/stýringu 16 | 700 mm (2)  | 595 mm          | 28 / 8 mm      | Krómm | 10       |
| 60800   | IPA Gluggalæsing m/stýringu 16 | 800 mm (2)  | 695 mm          | 28 / 8 mm      | Krómm | 10       |
| 60900   | IPA Gluggalæsing m/stýringu 16 | 900 mm (2)  | 795 mm          | 28 / 8 mm      | Krómm | 10       |
| 61000   | IPA Gluggalæsing m/stýringu 16 | 1000 mm (2) | 895 mm          | 28 / 8 mm      | Krómm | 10       |
| 61100   | IPA Gluggalæsing m/stýringu 16 | 1100 mm (2) | 995 mm          | 28 / 8 mm      | Krómm | 10       |
| 61200   | IPA Gluggalæsing m/stýringu 16 | 1200 mm (2) | 1095 mm         | 28 / 8 mm      | Krómm | 10       |





## Stangarlæsingar fyrir svalahurðir og hliðhengd fög

|                |                       |
|----------------|-----------------------|
| Stólpi         | 16/17 mm              |
| Efni           | Járn                  |
| Yfirborð       | Krómað                |
| Kólvar         | 17 mm                 |
| Fjöldi Kólva   | 2 stk. (440-1420mm)   |
| Fjöldi Kólva   | 3 stk. Svalahurðaskrá |
| Húnagat        | 8 mm                  |
| Húnagatsdýpt   | 28 mm/Svalas.40 mm    |
| Láshússdýpt    | 37 mm/Svalas.49 mm    |
| Lengd          | Í töflu               |
| Lengd m/ kólva | Í töflu               |

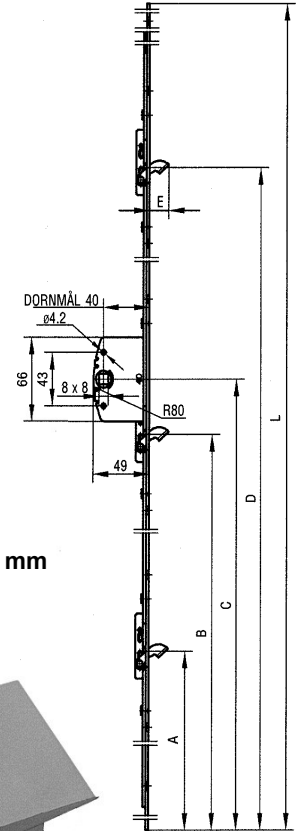
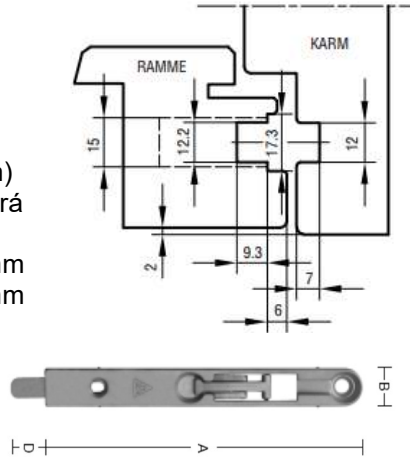

Kantrílar B = 17 mm / A = 128 mm / D = Ríll 20 mm  
Vörunr. 63333



Ryðfritt Mótstykki f/ stangarlæsingar  
Vörunr: 62903



Mótstykki f/ stangarlæsingar  
Vörunr: 62900

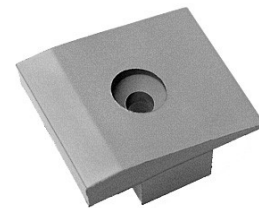

Stýriklossi fyrir opnanleg fög  
Vörunr.61910

!3551-53

| Vörunr. | Vöruheiti / Stólpi mm         | Lengd (kólvar) | Milli kólva  | Litur | Dýpt/Húngat | Pakkning |
|---------|-------------------------------|----------------|--------------|-------|-------------|----------|
| 63044   | IPA Gluggalæsing f/ hliðh./16 | 440 mm (2)     | 100 mm       | Króm  | 28 / 8 mm   | 10       |
| 63060   | IPA Gluggalæsing f/ hliðh./16 | 600 mm (2)     | 280 mm       | Króm  | 28 / 8 mm   | 10       |
| 63072   | IPA Gluggalæsing f/ hliðh./16 | 720 mm (2)     | 280 mm       | Króm  | 28 / 8 mm   | 10       |
| 63082   | IPA Gluggalæsing f/ hliðh./16 | 820 mm (2)     | 380 mm       | Króm  | 28 / 8 mm   | 10       |
| 63092   | IPA Gluggalæsing f/ hliðh./16 | 920 mm (2)     | 480 mm       | Króm  | 28 / 8 mm   | 10       |
| 63102   | IPA Gluggalæsing f/ hliðh./16 | 1020 mm (2)    | 580 mm       | Króm  | 28 / 8 mm   | 10       |
| 63112   | IPA Gluggalæsing f/ hliðh./16 | 1120 mm (2)    | 680 mm       | Króm  | 28 / 8 mm   | 10       |
| 63122   | IPA Gluggalæsing f/ hliðh./16 | 1220 mm (2)    | 780 mm       | Króm  | 28 / 8 mm   | 10       |
| 63132   | IPA Gluggalæsing f/ hliðh./16 | 1320 mm (2)    | 880 mm       | Króm  | 28 / 8 mm   | 10       |
| 63142   | IPA Gluggalæsing f/ hliðh./16 | 1420 mm (2)    | 970 mm       | Króm  | 28 / 8 mm   | 10       |
| 62110   | IPA Svalahurðaskrá /16/17     | 2110 mm (3)    | 740<m>740 mm | Króm  | 40 / 8 mm   | 10       |



## Bremsur fyrir hliðhengdar læsingar



63212-4



Bremsa 418580

| Vörunr. | Vöruheiti                        | Lengd (kólvar) | Fræsing       | Litur  | Pakkning |
|---------|----------------------------------|----------------|---------------|--------|----------|
| 63200   | IPA Bremsa f/hliðh.glugga        | 330-480 mm     | 12x10/16x3 mm | silfur | 10       |
| 63202   | IPA Bremsa f/hliðh.glugga        | 481-690 mm     | 12x10/16x3 mm | silfur | 10       |
| 63204   | IPA Bremsa f/hliðh.glugga+hurðir | 691-900 mm     | 12x10/16x3 mm | silfur | 10       |
| 63206   | IPA Bremsa f/hliðh.glugga+hurðir | 901-1100 mm    | 12x10/16x3 mm | silfur | 10       |
| 63208   | IPA Mótstykki f/ bremsu. IPA nót | 12x9 mm        | 12x9 mm       | grátt  | 10       |
| 63210   | IPA Mótstykki f/ bremsu. PN nót  | 16x5 mm        | 16x5 mm       | grátt  | 10       |
| 63212   | IPA Tengikúpling f/ bremsu       | 63 mm          |               | galv.  | 10       |
| 63214   | IPA Tengikúpling f/ bremsu       | 100 mm         |               | galv.  | 10       |
| 418580  | IPA Bremsa 16x5 f/ HH glugga     | 274 mm         | 16x5 mm       | silfur | 25       |



Handföng með tungu f/ Ál-prófil



Handföng satin silfur flöt f/ IPA læsingar



Handföng með tungu og næturopnun

| Vörunr. | Vöruheiti                              | Lengd   | H eða V       | Litur  | Stærð pinna | Pakkning |
|---------|--|---------|---------------|--------|-------------|----------|
| 61975-6 | Handföng f/ læsingar satin silfur flöt | 12,5 cm | Hægri/Vinstri | Silfur | 8 mm        | 10       |
| 40101-2 | Handföng m/ tungu og næturopnun        | 12 cm   | Hægri/Vinstri | Hvít   | Utanáliggj. | 40       |
| 40103-4 | Handföng m/ tungu og næturopnun        | 12 cm   | Hægri/Vinstri | Silfur | Utanáliggj. | 40       |
| 40046-7 | Handföng m/ tungu f/ Ál-prófil         | 16 cm   | Hægri/Vinstri | Hvít   | Utanáliggj. | 50       |
| 40053-4 | Handföng m/ tungu f/ Ál-prófil         | 16 cm   | Hægri/Vinstri | Silfur | Utanáliggj. | 50       |
| 40063   | Plata fyrir Ál-prófil karm. Plast      | 3x45mm  |               | Hvít   |             | 50       |
| 40066   | Plata fyrir Ál-prófil karm. Plast      | 6x45mm  |               | Hvít   |             | 50       |

## Bréfalúgur

### Bréfalúgur Plus Line

lúgurnar koma í fimm litum og eru í hæsta gæðaflokki, með þéttlista og bursta á mjög sanngjörnu verði.

| Vörunúmer | Vöruheiti | Litur    | Stærð                | Úrtak                 | Pakkning   |
|-----------|-----------|----------|----------------------|-----------------------|------------|
| 50030     | Plus Line | Svört    | B:30,8 cm x H:7,6 cm | B:28,5 cm x H: 4,8 cm | 15 í kassa |
| 50032     | Plus Line | Hvít     | B:30,8 cm x H:7,6 cm | B:28,5 cm x H: 4,8 cm | 15 í kassa |
| 50033     | Plus Line | Gull     | B:30,8 cm x H:7,6 cm | B:28,5 cm x H: 4,8 cm | 15 í kassa |
| 50035     | Plus Line | Silfur   | B:30,8 cm x H:7,6 cm | B:28,5 cm x H: 4,8 cm | 15 í kassa |
| 50038     | Plus Line | Graphite | B:30,8 cm x H:6,8 cm | B:28,5 cm x H: 4,8 cm | 15 í kassa |



## KDH Innihurðalamir / Eldvarnarlamir

KDH hurðalamirnar eru til í mörgum útfærslum. Þær eru framleiddar eftir ströngustu gæðakröfum og útfærðar sérstaklega fyrir hurðaframleiðendur á Íslandi.

KDH ryðfríu samstungnu 89x89 mm lamirnar (mynd til hægri) koma með oddmjóum pinna sem auðveldar uppsetningu. Pinninn er með kúlulegu.

Burðarþol á 3mm þykkum hurðalöllum, samstungum og pinna, er **60-80 kg per/3 stk. 80-100 kg per/4 stk.**

Burðarþol á 3,5 – 4,0 mm þykkum hurðalöllum er **80-120 kg per/3stk**



40037-38



40031-32-33-34  
(EN 1935:2002 / CE / SUS304)



40018



40019



40020

| Vörunn. | Vöruheiti               | Stærð     | Þykkt | Pinni | Efni                   | Pakkning |
|---------|-------------------------|-----------|-------|-------|------------------------|----------|
| 40018   | KDH Innihurðal. BS.     | 89x76 mm  | 3 mm  | 7 mm  | Burstað stál           | 50 pör   |
| 40019   | KDH Innihurðal. ME.     | 89x76 mm  | 3 mm  | 7 mm  | Messingh. Stál         | 50 pör   |
| 40020   | KDH Innihurðal. RF.     | 89x76 mm  | 3 mm  | 8 mm  | Ryðfrítt stál SS304    | 50 pör   |
| 40031*  | KDH Eldvarnarlamir      | 89x76 mm  | 3 mm  | 8 mm  | Ryðfrítt stál SS304    | 50 pör   |
| 40032*  | KDH Eldvarnarlamir      | 89x89 mm  | 3 mm  | 8 mm  | Ryðfrítt stál SS304    | 50 pör   |
| 40033*  | KDH Eldvarnarlamir      | 102x76 mm | 3 mm  | 8 mm  | Ryðfrítt stál SS304    | 50 pör   |
| 40034*  | KDH Eldvarnarlamir      | 102x89 mm | 3 mm  | 8 mm  | Ryðfrítt stál SS304    | 50 pör   |
| 40037   | Innih.I. INNIRF.Samst.H | 89x89 mm  | 3 mm  | 10 mm | Ryðfrítt SS201.hægri   | 50 pör   |
| 40038   | Innih.I. INNIRF.Samst.V | 89x89 mm  | 3 mm  | 10 mm | Ryðfrítt SS201.vinstri | 50 pör   |

\*Allar eldvarnarlamir eru með föstum pinna.

## KDH Útihurðalamir

Útihurðalamirnar koma í þremur stærðum og koma með legurnar í miðjunni til að auðvelda uppsetningu. Það er sitt hvor tegundin af ryðfríu stáli í blaði og pinna til að auka styrk og endingu. KDH 4"x4" "Messing" lamirnar eru messinghúðað ryðfrítt stál til að ná hámarks styrkleika. KDH 125mm prófil hurðalamir eru með hæðar stillanlegum pinna og fyrir 16mm droprauf.

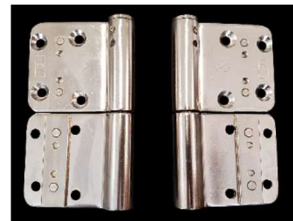

40013-14

| Vörunúmer | Vöruheiti            | Stærð      | Þykkt  | Pinni | Efni                       | Pakkning  |
|-----------|----------------------|------------|--------|-------|----------------------------|-----------|
| 40013     | KDH Prófil hurðal. H | 125 mm     | 4,0 mm | 10 mm | Ryðfrítt stál SS304        | 10/40 stk |
| 40014     | KDH Prófil hurðal. V | 125 mm     | 4,0 mm | 10 mm | Ryðfrítt stál SS304        | 10/40 stk |
| 40021     | Útihurðal. RF        | 102x89 mm  | 3 mm   | 8 mm  | Ryðfrítt stál SS304        | 50 pör    |
| 40022     | Útihurðal. RF        | 102x102 mm | 3 mm   | 8 mm  | Ryðfrítt stál SS304        | 50 pör    |
| 40023     | Útihurðal. ME        | 102x102 mm | 3 mm   | 8 mm  | RF stál mess.Húðað         | 50 pör    |
| 40027     | Útihurðal. RF        | 125x102 mm | 3,5 mm | 8 mm  | Ryðfrítt stál SS304        | 25 pör    |
| 40028     | Öryggislamir. RF     | 102x102 mm | 3 mm   | 8 mm  | Ryðfrítt stál <b>SS316</b> | 37 pör    |



40022



40023



40027



40028



## Kerfislamir fyrir hliðhengd fög

| Vörunúmer | Vöruheiti                 | Stærð fyrir | Efni / Yfirborð  | Pakkning |
|-----------|---------------------------|-------------|------------------|----------|
| 41901     | IPA Hliðhengd gluggalöm H | 90 mm       | Járn / Heitgalv. | 10       |
| 41902     | IPA Hliðhengd gluggalöm V | 90 mm       | Járn / Heitgalv. | 10       |
| 41955     | IPA Vinkillamir 11457. H  | 96 mm       | Járn / Heitgalv. | 10       |
| 41956     | IPA Vinkillamir 11457. V  | 96 mm       | Járn / Heitgalv. | 10       |

### Toppengsli fyrir prófillamir RF



40015 H – 40016 V



41905-6 41901-2



41955-6



## Istar 506 Felulamir

### Technical Data

Load capacity: 60 Kg (2X), 80 Kg (3X)  
 Height: 110 mm  
 Door width: 24 mm  
 Frame width: 24 mm  
 Opening angle: 180°  
**FINISHING**  
 Powder-coated:  
 Satin Chrome cod.14

#### Installation Demo

<https://www.youtube.com/watch?v=VtNP4n-IzvQ>

#### Milling Demo

[https://www.youtube.com/watch?v=3nSQJ27sc\\_E](https://www.youtube.com/watch?v=3nSQJ27sc_E)

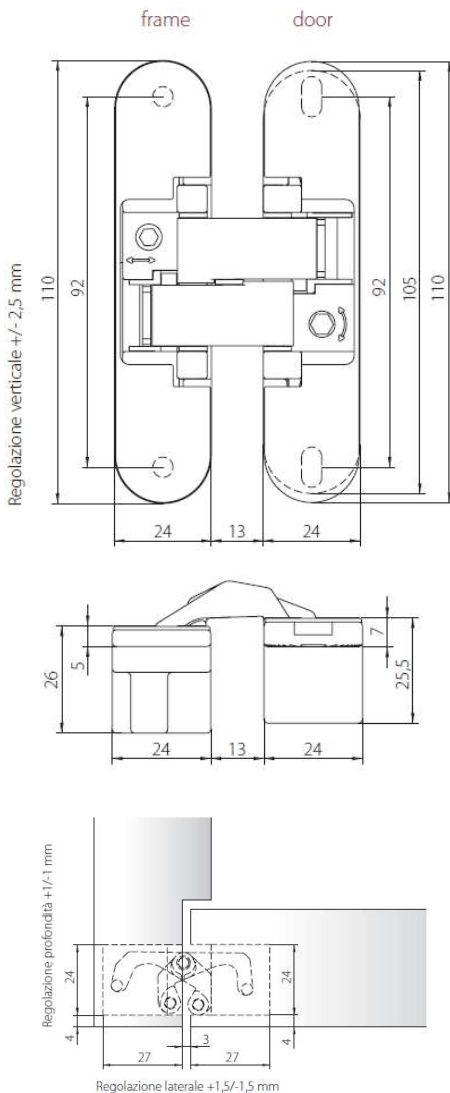

| Vörunúmer | Vöruheiti           | Efni       | Pakkning |
|-----------|---------------------|------------|----------|
| 39506     | Istar 506 Felulamir | Húðað járn | 2        |
| 39599     | Máti                |            | 1        |

### Adjustments

Height: +2,5 mm - 2,5 mm  
 Side: +1,5 mm - 1,5 mm  
 Depth: +1 mm - 1 mm

### Milling

Best cutter diameter: 14 or 16 mm  
 Collar ring: cutter diameter + 11 mm

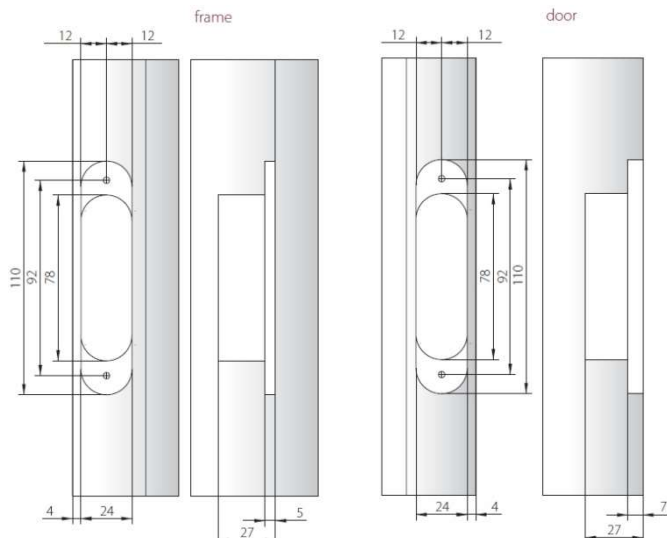

## Renson Sonoslot loftunarristar F/ opnanleg fög og karma

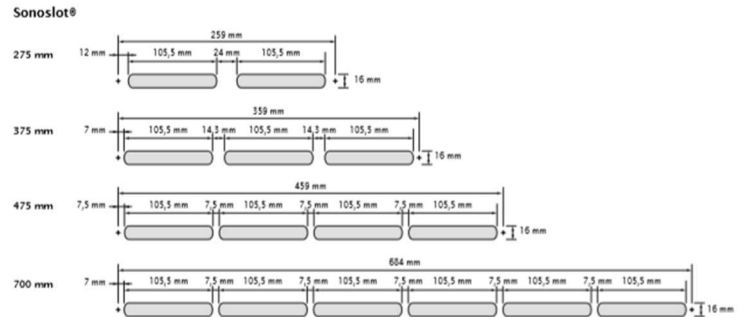
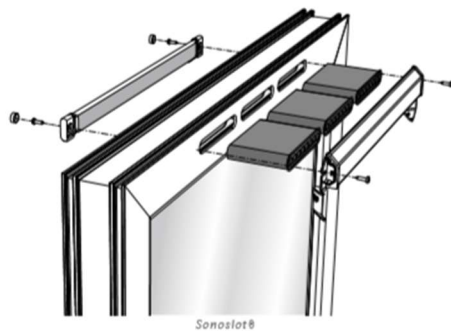

| Vörunúmer | Vöruheiti             | Litur / Stærð    | Pakkning |
|-----------|-----------------------|------------------|----------|
| 772182    | Renson Sonoslot Hvítt | RAL9010 / 275 mm | 1        |
| 772184    | Renson Sonoslot Brúnt | RAL8016 / 275 mm | 1        |

## Krossviður með Álpynnu



| Vörunúmer | Vöruheiti                  | Stærð              | Pakkning |
|-----------|----------------------------|--------------------|----------|
| 20013     | KV Stór Rásaður. Nót 4x8mm | 1250 x 2500 x 9 mm | 1        |
| 20014     | KV Stór Sléttur            | 1250 x 2500 x 9 mm | 1        |

## Q-LON Q-lon þéttlistar, Slottlisti og EPDM Toppf.listi

| Vörunúmer  | Vöruheiti                      | Litur             | Pakkning                      |
|------------|--------------------------------|-------------------|-------------------------------|
| 830782-3   | Q-lon 3078 þéttlisti           | Brúnn/Hvítur      | 250 m per/rl                  |
| 830731-2-3 | Q-lon 3073 þéttlisti           | Grár/Brúnn/Hvítur | 200 m per/rl                  |
| 830043     | Q-lon 3004 þéttlisti           | Hvítur            | 350 m per/rl                  |
| 830053     | Q-lon 3005 þéttlisti           | Hvítur            | 300 m per/rl                  |
| 84125      | Þéttlisti slottlisti f/kýlingu | Trans             | 100 m per/rl                  |
| *84835     | EPDM 4835 toppf.listi          | Svartur           | B 3,5-4 x D 4,5. 4,8 frá brún |

\* EPDM toppfyllingalistinn er settur í nút glerlista til glerjunar.

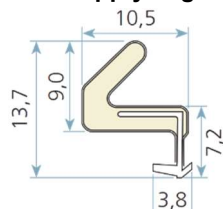

Q-lon 3078

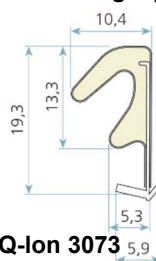

Q-lon 3073

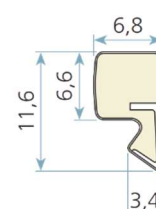

Q-lon 3005

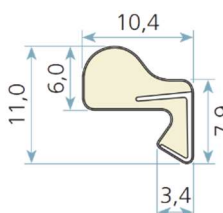

Q-lon 3004

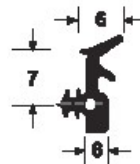

EPDM 4835

## Eldvarnar fellipröskuldar og Kerafix 2000 eldglerjunarborðar

| Vörunúmer | Vöruheiti                      | Úrtak í mm | Bil í mm | Db / Eldvörn | Pakkning |
|-----------|--------------------------------|------------|----------|--------------|----------|
| 640834    | Felliprösk.DSD1530 834 mm.     | D30 / B15  | 4-20     | 50 db / B30  | 1        |
| 640959    | Felliprösk.DSD1530 959 mm.     | D30 / B15  | 4-20     | 50 db / B30  | 1        |
| 641084    | Felliprösk.DSD1530 1084 mm     | D30 / B15  | 4-20     | 50 db / B30  | 1        |
| 641209    | Felliprösk.DSD1530 1209 mm     | D30 / B15  | 4-20     | 50 db / B30  | 1        |
| 82039     | Kerafix 2000 Eldvarnargl.listi | Hvítur     | 3x9 mm   | B30          | 50 m     |
| 82069     | Kerafix 2000 Eldvarnargl.listi | Hvítur     | 6x9 mm   | B30          | 50 m     |

### Deventer fellipröskuldar

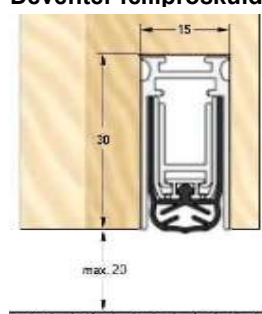

KERAFIX® 2000 Classic /



## ROLLTECH

### Ál-botnlistar

Rolltech ál botnlistarnir koma í þremur stærðum og þremur litum.

Állistarnir eru eloxeraðir og þar af leiðandi "hvítna" þeir ekki. Hvítu og brúnu állistarnir eru litaðir með púðurhitunar aðferð.

Allir állistarnir koma með gúmmílista.

Klossarnir eru fáanlegir fyrir slétt og hallandi (7°) föls.

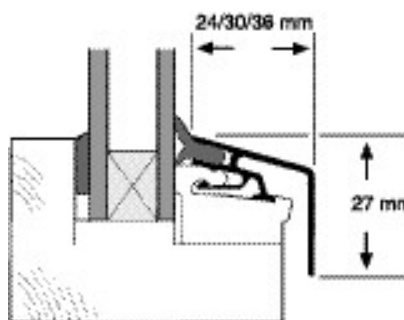

| Vörunúmer | Vöruheiti                              | Litur         | Eining |
|-----------|--|---------------|--------|
| 81524     | Ál- botnlisti - 24 mm. f/ opnanleg fög | Ál/Eloxeraður | 6 m    |
| 815241    | Ál- botnlisti - 24 mm. f/ opnanleg fög | Hvítur        | 6 m    |
| 815242    | Ál- botnlisti - 24 mm. f/ opnanleg fög | Brúnn         | 6 m    |
| 81530     | Ál- botnlisti - 30 mm. f/ föst fög     | Ál/Eloxeraður | 6 m    |
| 815301    | Ál- botnlisti - 30 mm. f/ föst fög     | Hvítur        | 6 m    |
| 815302    | Ál- botnlisti - 30 mm. f/ föst fög     | Brúnn         | 6 m    |
| 81536     | Ál- botnlisti - 36 mm. f/ föst fög     | Ál/Eloxeraður | 6 m    |
| 815361    | Ál- botnlisti - 36 mm. f/ föst fög     | Hvítur        | 6 m    |
| 815362    | Ál- botnlisti - 36 mm. f/ föst fög     | Brúnn         | 6 m    |
| 81610     | Klossar fyrir slétt föls               | Svartur       | 1 stk. |
| 81611     | Klossar fyrir hallandi föls            | Svartur       | 1 stk. |

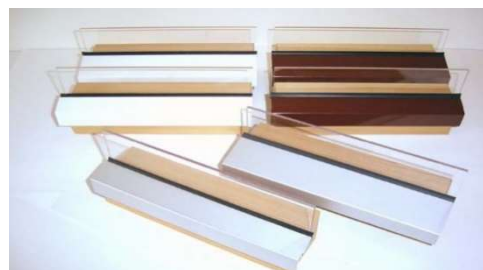
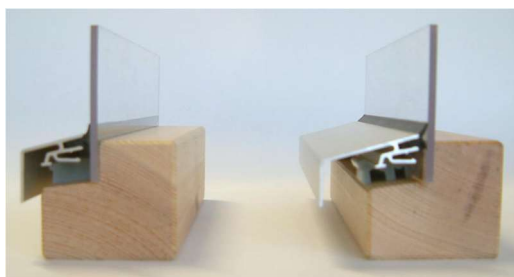



## Hurðapumpur

### OTS 210

G-U BKS OTS 210 Innihurðapumpurnar fyrir innihurðir.



### OTS 430

G-U BKS OTS 430 Inni og útihurðapumpur, Henta vel fyrir **B30 eldvarnarinnihurðir**.



### OTS 536

G-U BKS útihurðapumpur eru í hæsta gæðaflokki.

Nr. 2-6 (15-60 Nm). Fyrir flekastærð allt að 1400 mm á breidd. 180° opnun og auðvelt að stilla.



### OTS 730

G-U BKS útihurðapumpur eru í hæsta gæðaflokki. Nr. 3-6 (18-60 Nm). Fyrir flekastærð allt að 1400 mm á breidd. 180° opnun og auðvelt að stilla. 730 pumpan er fánleg fyrir braut (sjá mynd).



OTS 210 - 430 - 536



OTS 730 m/ braut

| Vörunr. | Vöruheiti               | BxH í mm                                      | Litur  | Stærð        | Hurðastærð breidd í mm | Pakkning |
|---------|-------------------------|---|--------|--------------|------------------------|----------|
| 52210   | G-U BKS OTS 210 2-4     | 207 x 58                                      | Silfur | 2-4          | 1100 x 2400            | 8 stk    |
| 52440   | G-U BKS OTS 430 2-5     | 236 x 58                                      | Silfur | 2-5          | 1250 x 2400            | 6 stk    |
| 52442   | G-U BKS Armur F/ 430    | Braut valkostur fyrir hurðapumpur OTS 210-430 |        |              |                        |          |
| 52444   | G-U BKS Braut F/210-430 |   |        |              |                        |          |
| 52446   | G-U BKS Bracket F/ 430  | Aukahlutur Fyrir OTS 430                      |        |              |                        |          |
| 52536   | G-U BKS 536 2-6         | 296 x 60                                      | Silfur | 2-6 15-60 Nm | 1400 x 2400            | 1 stk    |
| 52730   | G-U BKS OTS 730 3-6     | 370 x 60                                      | Silfur | 3-6 18-60 Nm | 1400 x 2400            | 1 stk    |
| 422026  | KDH Hurðastoppari       | 32 x 26 mm                                    | RF     |              |                        | 10 stk   |



**KDH Hurðastoppari RF.**  
Fyrir gólf og vegg. 32x26 mm



422026

## SCOOP Innihurðahúnarnir

með Slidebloc gormakerfi sem heldur þeim uppi.



1084



1106



1104

| Vörunr. | Vöruheiti                | Lengd  | Hæð   | Pinni | Þykkt | Efni / gat | Pakkning |
|---------|--------------------------|--------|-------|-------|-------|------------|----------|
| 431084  | Scoop RF hurðah.1084     | 132 mm | 60 mm | 8 mm  | 20 mm | RF / 38 mm | 1 stk    |
| 431104  | Scoop RF hurðah.1104     | 135 mm | 58 mm | 8 mm  | 20 mm | RF / 38 mm | 1 stk    |
| 431106  | Scoop RF hurðah.1106     | 135 mm | 58 mm | 8 mm  | 20 mm | RF / 38 mm | 1 stk    |
| 431200  | Scoop útihurðah.f/ 55/92 | 135 mm | 58 mm | 8 mm  | 20 mm | RF         | 1 stk    |
| 42190   | RF lykillauf f/lykla     | 54 mm  |       |       | 10 mm | RF         | 1 stk    |
| 42192   | RF lykillauf f/silindra  | 54 mm  |       |       | 10 mm | RF         | 1 stk    |
| 431111  | Scoop RF WC læsing       | 54 mm  |       | 8 mm  | 10 mm | RF / 38 mm | 1 stk    |



431200

Þýsk gæði á frábæru verði

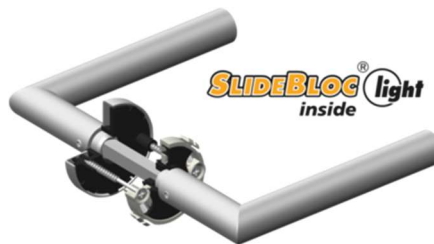

431111



42190

42192

## G-U BKS Útihurðahúnar

| Vörunr. | Vöruheiti                 | Breidd | Hæð    | Þykkt | Efni / gat | Pakkning |
|---------|---------------------------|--------|--------|-------|------------|----------|
| 622871  | G-U Handfang Neptune      | 24 mm  | 234 mm | 10 mm | Matt króm  | 1 stk    |
| 622872  | G-U Handfang Neptune      | 40 mm  | 234 mm | 10 mm | Matt króm  | 1 stk    |
| 622873  | G-U Handf.Neptune.m/hnúð  | 40 mm  | 234 mm | 10 mm | Matt króm  | 1 stk    |
| 622880  | FabnFix Balmoral Graphite | 32 mm  | 243 mm | 10 mm | Graphite   | 1 stk    |

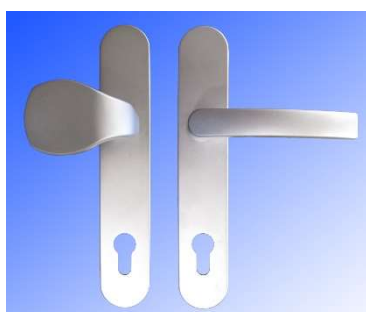

Neptune



Balmoral

## SCOOP

### Ryðfríar Hurðaslár

#### Flatline



| Vörunúmer | Vöruheiti     | Hæð     | Þykkt | Efni          | Pakkning |
|-----------|---------------|---------|-------|---------------|----------|
| 411203    | Flatline 1000 | 1000 mm | mm    | Ryðfrítt stál | 1        |
| 411204    | Flatline 1200 | 1200 mm | mm    | Ryðfrítt stál | 1        |

#### Inline



| Vörunúmer | Vöruheiti               | Hæð / Festing | Þykkt | Efni          | Pakkning |
|-----------|-------------------------|---------------|-------|---------------|----------|
| 4121200   | Inline 1200             | 1200 mm / 2   | mm    | Ryðfrítt stál | 1        |
| 4121800   | Inline 1800             | 1800 mm / 3   | mm    | Ryðfrítt stál | 1        |
| 4122101   | Festingar. Gegnumg.     |               |       | Ryðfrítt stál | 1        |
| 4122105   | Festingar. INNI         |               |       | Ryðfrítt stál | 1        |
| 41180     | Festingar F/ In-Flatli. |               |       | Ryðfrítt stál | 1        |

## **KDH** Skápahöldur Úr gegnheilu ryðfríu stáli

### Skápahöldur Nr.005

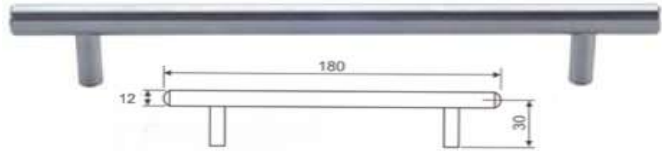

Ryðfríar 12 mm höldur til í stærðum (Lengd milli gata)  
128 mm, 160 mm, 192 mm, 256 mm, 320 mm,  
400 mm, 500 mm, 600 mm, 700 mm, 800 mm,  
900 mm, 1000 mm, 1200 mm, 1400 mm, 1600 mm.  
Heildarlengd höldu er lengd.m.gata + 50 mm

### Skápahöldur Nr.006

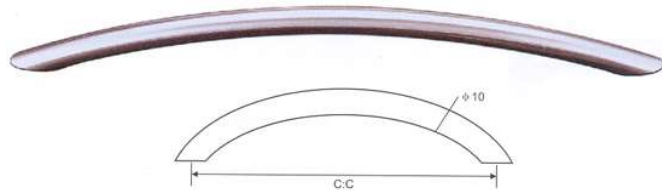

Ryðfríar 10 mm höldur til í stærðum  
96 mm, 128 mm, 192 mm, 320 mm.

### Skápahöldur NR.007

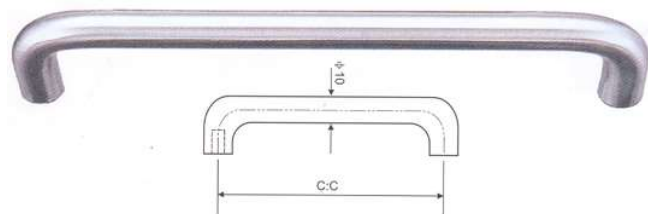

Ryðfríar 10 mm höldur til í stærðum  
96 mm, 128 mm, 192 mm, 256 mm, 320 mm,



449039



449042



448064

| Vörunúmer | Vöruheiti          | Hæð   | Þykkt | Efni          | Pakkning |
|-----------|--------------------|-------|-------|---------------|----------|
| 449039    | KDH hnúðar RF      | 28 mm | 25 mm | Ryðfrítt stál | 20       |
| 449042    | KDH hnúðar RF      | 29 mm | 25 mm | Ryðfrítt stál | 20       |
| 448064    | Skápahöldur Nr.008 | 64 mm | 10 mm | Ryðfrítt      | 50 / 200 |



## G-U 934 Rennihurða fittings

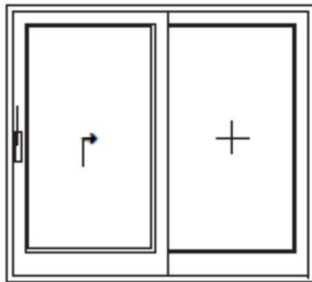

Einföld

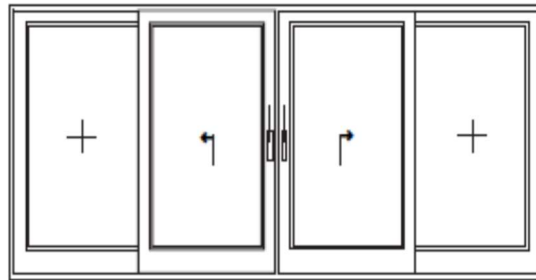

Tvöföld

| Vörunúmer | Vöruheiti                            | lengd  |
|-----------|--------------------------------------|--------|
| 6709547   | GU - Botnbraut 934 f/ RH - Ál        | 4 m    |
| 6710566   | GU - Toppskúffa 45 mm / K-10894 - Ál | 4 m    |
| 6716488   | GU - Hjól f/ RH 934/954              |        |
| 6716606   | GU - Lásbolta fittings f/ RH 934/954 |        |
| 6724606   | GU - Handfang Ál f/ RH EV1           |        |
| 6725476   | GU - Tengijárn f/ RH læsing 30021    | 1,86 m |
| 6729526   | GU - Halda innfelld Ál f/ RH 934/954 |        |
| 6730021   | GU - Læsing f/ RH 934/954 - 37,5 mm  | 2,28 m |
| 6735996   | GU - Þéttiklossi - Gúmmí f/ RH       |        |
| 6811051   | GU - Púðar f/ RH 934/954             |        |
| 6775101   | GU - Þéttilisti f/ RH P-743          |        |
| 6875103   | GU - Þéttilisti f/ RH P-1156         |        |
| 6875743   | GU - Þéttilisti f/ RH P-742          |        |



## G-U 934 Rennihurða fittings / aukahlutir

| Vörunúmer | Vöruheiti                                     | lengd |
|-----------|---|-------|
| 6713267   | GU - Handfang tvöfalt úti-inni Ál / RH. EV1   |       |
| 6716793   | GU - Handfang Ryðfrítt m/ höldu f/ RH         |       |
| 6816607   | GU - Lásbolta fittings f/ tvöföldun f/ RH 934 |       |
| 6815797   | GU - Samlokulisti f/ RH 934/954 10 mm         | 2,4 m |
| 6815798   | GU - Samlokulisti f/ RH 934/954 16 mm         | 2,4 m |

| Type of element   | GU-934 door   |
|-------------------|---------------|
| Sash weight in kg | up to 300*    |
| Sash width, mm    | 700 - 3300    |
| Sash height, mm   | 1851 - 3250** |



## Einnotahanskar úr nitril frá Imtex. Sterkir þægilegir



Senzi



X-Soft

| Vörunr.     | Vöruheiti / Stærðir        | Lengd  | Þykkt   | Efni / litur    | Pakkning        |
|-------------|----------------------------|--------|---------|-----------------|-----------------|
| 90013-14-15 | Einnotah. Sensi / S-M-L-XL | 240 mm | 0,06 mm | Nitril / Hvítir | 100 stk / 10 ks |
| 90010-11-12 | Einnotah. X-Soft / M-L-XL  | 240 mm | 0,10 mm | Nitril / Bláir  | 100 stk / 10 ks |



| Vörunr. | Vöruheiti / Stærðir    | Stærð      | Efni                          | Pakkning       |
|---------|------------------------|------------|-------------------------------|----------------|
| 90002   | Sitrix V1 Þurrkur      | 34 x 30 cm | 55% cellulose<br>45%polyester | 50 stk / 12 ks |
| 90001   | Sitrix V3 Þurrku Rúlla | 34 x 38 cm |                               | 500 bl / 1 rl  |



## Loftbyssur fyrir galv og RF pinna og hefti, polymer plast pinna og hefti.

(Þarf ekki að plokka úr fyrir fræsiténnur eða sagarblöð)



12.20 p (polymer)



17.55 p (polymer)



81 p (polymer)



MG 40 (pinnar RF/Galv)



90.40 (hefti 90)

| Vörunr. | Vöruheiti                             | Pinna / hefti mm | Magn í kassa | Pakkning |
|---------|---------------------------------------|------------------|--------------|----------|
| 321200  | Omer loftpinnabyssa 12.20 p           | 12 - 20 mm       |              | 1 stk    |
| 321216  | Omer polymer pinnar f/ 12.20 p        | 16 mm            | 2000         | 1 pk     |
| 321220  | Omer polymer pinnar f/ 12.20 p        | 20 mm            | 2000         | 1 pk     |
| 321700  | Omer loftpinnabyssa 17.55 p           | 20 - 55 mm       |              | 1stk     |
| 321725  | Omer polymer pinnar f/ 17.55 p        | 25 mm            | 2350         | 1 pk     |
| 321732  | Omer polymer pinnar f/ 17.55 p        | 32 mm            | 2350         | 1 pk     |
| 328100  | Omer loftheftibyssa 81 p              | 6 - 14 mm        |              | 1 stk    |
| 328110  | Omer polymer hefti f/ 81 p            | 10 mm            | 5040         | 1 pk     |
| 328114  | Omer polymer hefti f/ 81 p            | 14 mm            | 5040         | 1 pk     |
| 328540  | Omer loftpinnab. MG 40. RF/Galv.      | 12 - 40mm        |              | 1 stk    |
| 328430  | Omer pinnar - hauslaus 30 mm - Galv.  | 30 mm (MG40)     | 14000        | 1 pk     |
| 328530  | Omer pinnar - m/ haus 30mm - RF. i304 | 30 mm (MG40)     | 12500        | 1 pk     |
| 329040  | Omer loftheftibyssa Nr. 90 RF/Galv.   | 20 - 40mm        |              | 1 stk    |
| 329090  | Omer hefti Nr.90. RF. i304            | 32 mm            | 5000         | 1 pk     |